

Digital Pressure Gauge Bluetooth XY-PG281

Typical Feature

- 330° rotatable display dial plate
- Large LCD screen, support reset, backlight
- Bluetooth connection, APP collection and other functions
- Accuracy level: Pressure 0.2% FS and 0.5%FS
- Powered by 2 pcs of AA Battery power, standby time 12 Months
- MAX&MIN value
- Multi pressure multiunit switching
(MPa/bar/kgf/mH2O/PSI/kPa/mmHg/mBAR/mmH2O/Pa/inWC)



Brief Introduction







XY-PG281 is a digital pressure gauge with a built-in high-precision pressure, which can accurately display the pressure in real time, and has the characteristics of high precision and good long-term stability. This digital pressure gauge is equipped with a large-size LCD,.

Which has multiple functions such as zero reset, backlight, power on and off, unit switching, low voltage alarm, etc. It is easy to operate and install. The dial orientation can be rotated 330°, which is convenient for customers to read from the desired angle. XY-PG281 product adopts the whole casing to be covered with rubber, which has good shock resistance and can measure gas, liquid, oil and other media that are not corrosive to stainless steel.

This series of products supports Bluetooth applets and APP configuration parameters, including: pressure value display, acquisition rate modification, reset operation and other settings.

XY-PG281 digital pressure gauge is suitable for portable pressure measurement, equipment matching, calibration equipment and other pressure measurement fields.

Suggested Applications

-  Machinery and electronic industry
-  Supporting equipment of instruments
-  Pressure laboratory
-  Mechanical engineering automation
-  Replacement of pointer pressure gauge
-  Customized applications

More details for XY-PG281, please contact us.

Specification

Model	XY-PG281
Negative/compound pressure	-0.1~0...0.1...1.6MPa
Differential pressure	0~10...40...60kPa
Normal pressure	0~0.1...1.0...6MPa
High Pressure	0~10...25...60MPa
Overload pressure	120% (≥ 10 MPa); 150% (< 10 MPa)
Appearance size	143.5*75*40.5mm
Measurement Medium	oil, water, gas, etc. Non-corrosive medium
Accuracy Level	0.2%FS ;0.5%FS
Long-Term Stability/Year	Typical: 0.3%FS/year
Operation Temperature	-20 - 65°C
Compensation Temperature	0 ~ 60°C
Thread Connection	M20*1.5, G1/4 or customized
Connector material	304 SS
Shell material	TPE+ABS
Output Connection	Bluetooth connection
Working Humidity	<85%
Display	4 digits LCD, white backlit display
Protection class	IP54
Power Supply	Battery 3V

Dimension(mm)

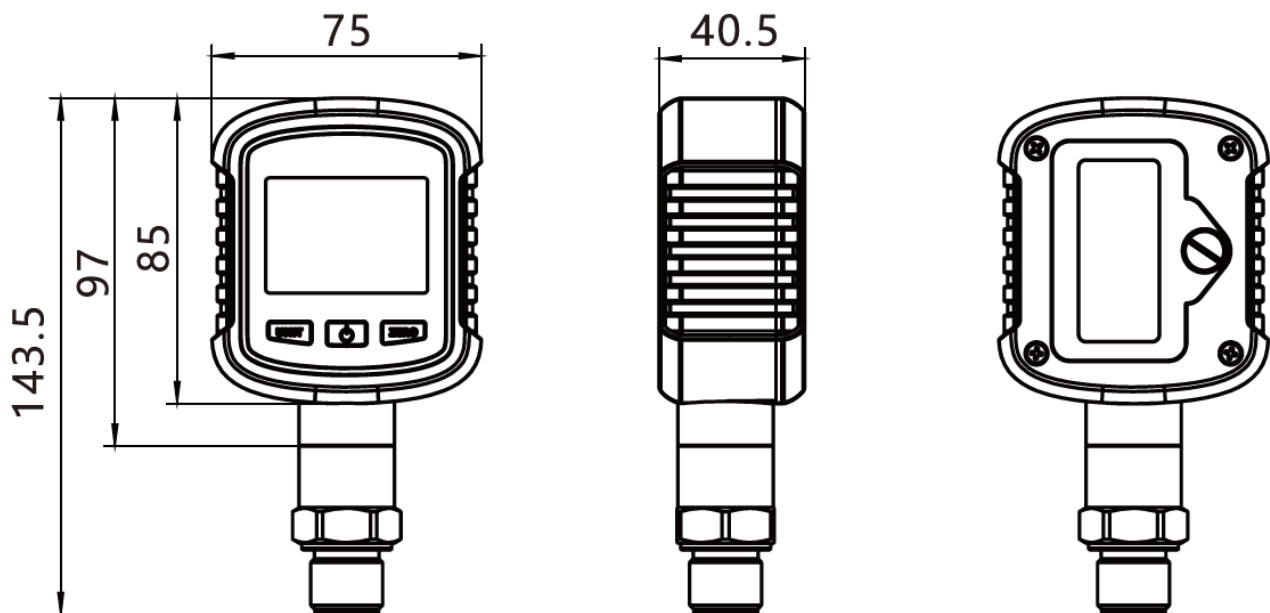

How To Order

XY-	PG	280	E	P	60M	I	P2	J	M3	B1	T1	L													
	Category	Type	Setup	Pressure Connection	Pressure Range	Accuracy	Power	Output	Thread	Electrical Connection	Medium Temperature	Additional													
PG	Pressure Gauge	200	High Accuracy	E	Lower Mount	None	General Thread	XK	0-XXPa	1	0.40%	P0	Battery	R	RS485	M1	M20x1.5	B	Cable Outlet	T1	-5~40°C	LC	LCD Display		
		210	High Accuracy Pressure&Temperature	Z	Panel Mount	P	Diaphragm Seals	XB	0-XXBar	2	0.20%	P2	24V	B	Bluetooth	M2	G1/4	C	Circular Connector	T2	-20~80°C	LE	LED Display		
		260	80mm Dial Size	G	Wireless	DP	Differential Pressure	MM	0-XXMPa	3	0.10%	P4	220V	A	±20mA	M3	G1/2	CC	Customized	T3	-20~65°C		Explosion-Proof		
		270	Explosion-Proof	F	Peak Record	MF	Flange	QSP	0-XXSPa	4	0.50%	P5	80V	D	Relay	M4	G2NPT								
		280	80mm Dial Size LCD Display	V	Vacuum Switch	DN	Flange	Kna	0-XXPa	5	0.25%	P6	12V	M2	Dual Relay	M5	1/4NPT								
		281	330° Rotated dial	W	Water Pump Switch	9999	Customized	CC	Customized	8	Customized	P9	Customized	CC	Customized	M7	ZG1/4								
		300	100mm Dial Size	L	LAPP											M8	Customized								
		380	80mm Dial Size LED Display																						
		560	Digital Remote-transmission																						
		655	Contact 80mm Dial Size																						
		655	Contact 80mm Dial Size																						
		625	Contact 90mm Dial Size																						
		625	Contact 90mm Dial Size																						
		628	60mm Dial Size																						
		PS	Pressure Switch	628	80mm Dial Size																				
628	80mm Dial Size																								
628	100mm Dial Size																								
650	Switch Box with Plastic Shell																								
PC	Pressure Control	600	Switch Box with Full Metal Shell																						
		600	80mm Dial Size																						
		800	80mm Dial Size																						
		800	100mm Dial Size																						

Remark: 1. This form is for whole Pressure Measurement and Pressure Control products, please read Product Date Sheet to get reference informations
2. If you may not find right information in this form, Please contact us to get future details

Shanghai XuYan Precision Technology Co., Ltd.

Address: No. 969, YunHan Road Pudong District Shanghai City China

Tel: +86 21 59241315

Email: sales@xvyanprecision.com

Website: www.xvyanprecision.com

Product Manager: Tyler Tou

Cell: +86 189 1797 0680

Email: Tylertou@xvyanpercision.com