

Digital Pressure Controller XY-PC800E

Typical Feature

- Stainless steel 304 shell, dial diameter $\Phi 80\text{mm}$
- 4-Digits LED Display,
- Multi-unit convert MPa/Kgf/cm²/PSI
- Accuracy level:0.5%FS
- Power supply 12 or 24VDC; Optional 220VAC
- Relay output signal NONC
- High precision, quick response time, stable and easy setting up



Brief Introduction











XY-PC800E is an Intelligent Digital Pressure Controller, with 80mm diameter stainless steel shell, integrating pressure measurement, display and control function. It has a variety of excellent functions, such as one-button reset, Multi-pressure Unit Converting and it's easy to reset setting, adjusting and installation.

This series of digital pressure controller has one relay, which can be set up normally open and normally close; these alarm points to control high and low pressure of air or liquid, in addition, it is with one key reset, at the same time, calibration, shifting display unit, setting return difference and others option functions.

The intelligent pressure controller is equipped with high-precision instrument amplifier to amplify pressure signal, built-in temperature compensation sensor, is the high precision equipment for detecting and monitoring pressure , strong anti-electromagnetic interference (EMI), surge protection, reverse protection and so on

XY-PC800E Intelligent Digital Pressure Controller can be widely used in Automatic System, Mobile Working Machines, Medical Equipment, Pump, Compressor, Energy and Water Treatment, Agricultural Equipment, Test System, Hydraulic System and Pneumatic System.

Suggested Applications

-  Equipment Automation
-  Mobile Work Machine
-  Water Pump and Air compressor
-  Electromechanical Equipment Automation
-  Energy and Water Treatment System
-  Medical Equipment
-  Hydraulic and Pneumatic Systems
-  Agricultural Equipment
-  Test Jig
-  Customized Applications

More details for XY-PC800E, please contact us.

Specification

Model	XY-PC800E
Gauge Pressure Range	0…0.2…0.6…1.0…1.6…2.5…5…10…25…40…60…100…160MPa
Micro Pressure Range	0~5…10…25…50…100KPa
Vacuum Pressure Range	-100~0KPa
Overload Capacity	200%(≤10MPa); 150%(>10MPa)
Measurement Medium	Gas or oil or other Liquid with Compatibility of SS 304 or 316
Accuracy Level	0.5%FS;
Long-Term Stability/Year	Typical: ±0.5% FS;
Sampling frequency	5times/second
Alarm Point	Any pressure @whole measurement range
Output	Relay Signal
Relay Capacity	220VAC 5A; 24VDC 5A
Electric protection	Short-circuit protection; Reverse connect protection; Anti-EMI
Display	4 digits LED
Operating temperature	-20~80°C
Compensation	-10~60°C
Power Supply	12/24VDC
Mechanical Connector	M2081.5; G1/2; G1/4

Dimension(mm)

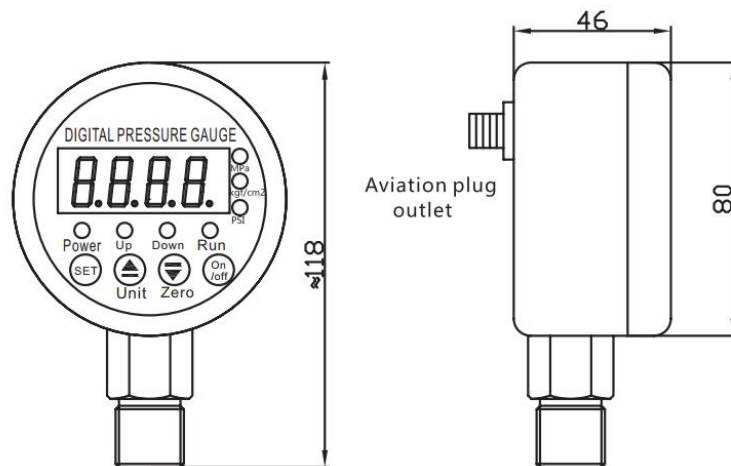

Output

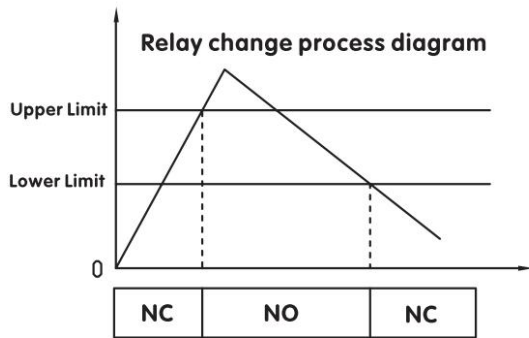

Outlet Line

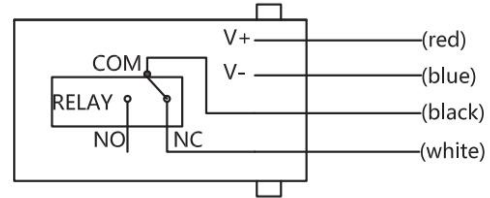

***Reverse control is available
(Low pressure to start, high pressure to stop)**

How To Order

XY-	PG	280	E	P	60M	I	P2	J	M3	B1	T1	L
Category	Type	Setup	Pressure Connection	Pressure Range	Accuracy	Power	Output	Thread	Electrical Connection	Medium Temperature	Additional	
PG	Pressure Gauge	200 High Accuracy	E Lower Mount	None General Thread	XX (0-2kPa)	1 0.40%	P0 Battery	B RS485	M1 M20x1.5	B Cable Outlet	T1 -5~40°C	LC LCD Display
		210 High Accuracy Pressure&Temperature	Z Panel Mount	P Diaphragm Seals	XB (0-2Bar)	2 0.20%	P2 24V	A 4-20mA	M2 G1/4	C Circular Connector	T2 -20~80°C	LF LCD Display
		270 Explosion-Proof	G Wireless	DP Differential Pressure	XM (0-2MPa)	3 0.10%	P4 220V	J1 Relay	M3 G1/2	CC Customized	T9 Customized	I1 Explosion-Proof
		280 80mm Dial Size LCD Display	F Peak Record	KE Clamp	LC Customized	4 0.50%	P5 380V	J2 Dual Relay	M4 1/2NPT			
		280 60mm Dial Size	V Vacuum Switch	DN Flange		5 0.25%	P6 12V	CC Customized	M5 1/4NPT			
		300 100mm Dial Size	W Water Pump Switch	9999 Customized		9 Customized	P9 Customized		M9 Customized			
		380 80mm Dial Size LED Display										
		480 Digital Remote-Transmission										
		605 Contact 60mm Dial Size										
		605 Contact 80mm Dial Size										
PS	Pressure Switch	408 80mm Dial Size										
		508 80mm Dial Size										
		508 100mm Dial Size										
		600 Switch Box with Plastic Shell										
		600 Switch Box with Full Metal Shell										
PC	Pressure Control	100 60mm Dial Size										
		800 80mm Dial Size										
		900 100mm Dial Size										

Remark: 1. This form is for whole Pressure Measurement and Pressure Control products, please read Product Date Sheet to get reference informations
2. If you may not find right information in this form, Please contact us to get future details

Shanghai XuYan Precision Technology Co., Ltd.

Address: No. 969, YunHan Road Pudong District Shanghai City China

Tel: +86 21 59241315

Email: sales@xvyanprecision.com

Website: www.xvyanprecision.com

Product Manager: Tyler Tou

Cell: +86 189 1797 0680

Email: ttao@Xuyanpercision.com