

## Digital Pressure Gauge XY-PG280

### Typical Feature

- Stainless steel 304 shell, dial diameter 80mm
- 4-Digits LCD with white backlight
- Low power design, optional battery and power supply
- Accuracy level: Pressure 0.2%;0.4%
- Pressure range -0.1~0...0.01...0.1...1.6...10...160MPa
- With more customized types for option











### Brief Introduction

XY-PG280 series Digital Pressure Gauge is low power consumption and optional wireless output, Peak value record, sanitation standard, wireless communication protocol is optional GPRS, LORa-iot, NB-iot. The high precision pressure sensor was built-in, quick response time to display accurately in real time, at the same time it has high precision and long-term stability; stainless-steel shell and joint with good shock resistance, thus it is suitable to measure gas, liquid, oil and other stainless steel without corrosion medium

These series digital pressure gauge is equipped with large-sized LCD display, it's easy to read data on site, at the same time upload record to cloud server, upload rate can be adjusted from 1 minute to 24 hours.

It's a real perfect wireless digital pressure gauge for Fire Water Pipe Network, Fire Alarm Station, Fire Pump Room, Water Supply, Petrochemical and Others filed required remote monitoring. It is alternative for the system involved by pressure transmitter, transmission module and power distribution box, consider its small size, convenient installation and cost-effective. They powered by Battery, 24VDC power supply is optional.

### Suggested Applications

-  Water Treatment System
-  Water Pump and Air compressor
-  Electromechanical Equipment Automation
-  Engineering Machinery
-  Medical Equipment
-  Hydraulic and Pneumatic Systems
-  Laboratory
-  Customized Applications

[More details for XY-PG280, please contact us.](#)

### Specification

Model	XY-PG280
General Pressure Range	0~0.2...0.6...1...2.5...10...25...40...60...100...160MPa
Micro-pressure Range	(0~5...10...25...40...60...100) KPa
Composite range	(-0.1~0...0.1...0.25...0.4...0.6...1...1.6...2.5) MPa (-10~10; -25~25; -40~40; -60~60; -100~100) KPa

Pressure Type	Gauge Pressure Test, Vacuum Pressure Test
Dimension	Φ80mm; Thickness 48mm
Overload Capacity	150% (>10MPa); 200% (≤10MPa)
Measurement Medium	Gas or Liquid with Compatibility of SS 316
Accuracy Level	0.2%FS ;0.4%FS
Long-Term Stability/Year	Typical: ±0.2% FS
Operation Temperature	-20 ~ 70°C; -20~150°C are customized
Compensation Temperature	0 ~ 60°C
Working Humidity	<85%
Display	4 digits LCD, white backlit display
Alarm Point Set	High & Low alarm points can be set within range
Power Supply	Battery 3V; 24VDC, 220VAC are optional

Dimension(mm)

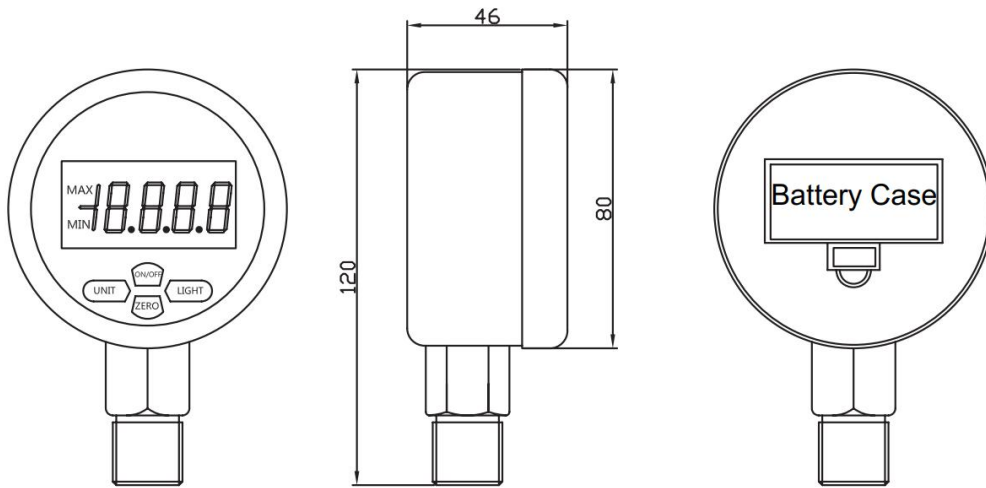

Mechanical Connection(mm)

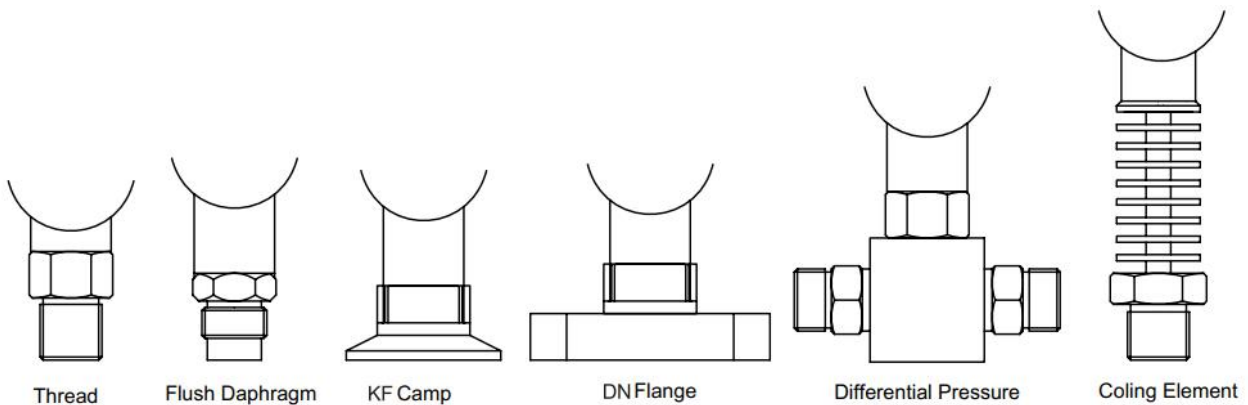

## How To Order

XY-	PG	280	E	P	60M	I	P2	J	M3	B1	T1	L			
	Category	Type	Setup	Pressure Connection	Pressure Range	Accuracy	Power	Output	Thread	Electrical Connection	Medium Temperature	Additional			
PG	Pressure Gauge	200	High Accuracy	E Lower Mount	None	General Thread	XX (0-XXPa)	1	0.40%	P0 Battery	R RS485	M1 M20*1.5	B Cable Outlet	T1 5~40°C	LC LCD Display
		210	High Accuracy Pressure&Temperature	Z Panel Mount	P	Diaphragm Seals	XB (0-XXBar)	2	0.20%	P2 24V	A 4-20mA	M2 G1/4	C Circular Connector	T2 -20~80°C	LE LED Display
		270	Explosion-Proof	G Wireless	DP	Differential Pressure	XM (0-XXMPa)	3	0.10%	P4 220V	J1 Relay	M3 G1/2	CC Customized	T9 Customized	I Explosion-Proof
		280	80mm Dial Size LCD Display	F Peak Record	KF	Clamp	CC Customized	4	0.50%	P5 380V	J2 Dual Relay	M4 1/2NPT			
		260	60mm Dial Size	V Vacuum Switch	DN	Flange		5	0.25%	P6 12V	CC Customized	M5 1/4NPT			
		300	100mm Dial Size	W Water Pump Switch	9999	Customized		9	Customized	P9 Customized		M7 25314			
		380	80mm Dial Size LED Display									M9 Customized			
		560	Digital Remote-transmission												
		625	Contact 60mm Dial Size												
		825	Contact 80mm Dial Size												
PS	Pressure Switch	628	60mm Dial Size												
		828	80mm Dial Size												
		928	100mm Dial Size												
		650	Switch Box with Plastic Shell												
		600	Switch Box with Full Metal Shell												
PC	Pressure Control	700	Mechanical												
		600	60mm Dial Size												
		800	80mm Dial Size												
		900	100mm Dial Size												

Remark: 1. This form is for whole Pressure Measurement and Pressure Control products, please read Product Date Sheet to get reference informations  
2. If you may not find right information in this form, Please contact us to get future details

## Shanghai XuYan Precision Technology Co., Ltd.

**Address:** No. 969, YunHan Road Pudong District Shanghai City China

**Tel:** +86 21 59241315

**Email:** sales@xvyanprecision.com

**Website:** [www.xvyanprecision.com](http://www.xvyanprecision.com)

**Product Manager:** Tyler Tou

**Cell:** +86 189 1797 0680

**Email:** ttao@Xuyanpercision.com