

Pressure Transmitter XY-PTG1210

Typical Feature

- Industrial 2088 explosion-proof shell, customizable different types of pressure connections
- Measurement Range -100KPa~300MPa are optional
- High accuracy 0.15%FS;0.25%FS;0.5 %FS
- Setup, adjust and display on display screen directly
- Long-term stability, multi-defense anti-electromagnetic interference
- Application in open-air industrial field in harsh conditions









Brief Introduction

XY-PTG1210 Pressure Transmitter is an Explosion Proof high precision Industrial Pressure Transmitter, designed for factory automation, equipment monitoring and control, used in experimental equipment, power station, chemical plant automation control, air transport equipment, air filtration monitoring equipment, oil, natural gas and other industries.

The Industrial pressure sensor is made of high quality piezoresistive components, standard flameproof casting aluminum shell, the excellent operational amplifier circuit design support its excellent stability, reliability and excellent anti-interference ability, it works well in all-weather environments, able to against variety of harsh environments, it is one of the lowest installation cost pressure sensors in the field of industries. At the same time the optional display table head is convenient set up on site.

XY-PTG1210 Explosion proof differential pressure transmitter has casting aluminum shell, IP65 and IP67 Ingress protection, and Safety explosion-proof, it is able to withstand harsh rugged application environments, powered by 15-36 VDC, typical 24 VDC, standard electrical signal output 4-20mA, voltage are optional; it's an absolute pressure, gauge pressure and vacuum pressure meter; measure range -100KPa ~ 0 ~ 5KPa... 60MPa...300MPa, other customized measurement range is available; Thoughtful specialized electric circuit design, accuracy 0.15%FS、0.25%FS、0.5 %FS; Long-Term Stability $\pm 0.1\%FS/Year$.

Suggested Applications

-  Petrochemical industry
-  Engineering Machinery
-  Steel Industry
-  Pneumatic and Hydraulic
-  Agricultural Equipment
-  Hydromantic Test Frame
-  Electro-metallurgy
-  Energy and Water Treatment system
-  Other applications have similar requirements



More details for XY-PTG1210, please contact us.

Specification

Model	XY-PTG1210
General Pressure Range	-100KPa~0...5...100KPa...1...5...10...25...60MPa
Absolute Pressure	0~5KPa...10...20...100.1000KPa
Pressure Type	Gauge Pressure Test; Absolute Pressure
Dimension	Reference Dimension Drawing
Measurement Medium	Gas or Liquid with Compatibility of SS 316L
Overload Capacity	200%
Output Single	4-20mA; Voltage are optional
Power Supply	9-32VDC (Typical 24V)
Operating Temperature	-30-85°C
Compensation Temperature	-20-80°C
Zero Temperature Drift	Typical: $\pm 0.02\%FS/^\circ C$
Sensitivity Temperature Drift	Typical: $\pm 0.02\%FS/^\circ C$
Load Resistance	$\leq [(U-16)/0.02A] \Omega$
Vibration Error	$\leq \pm 0.01\%FS$ (X, Y, Z 200Hz/g)
Accuracy	0.15%FS, 0.25%FS, 0.5%FS
Long-Term Stability/Year	Typical: $\pm 0.1\% FS/Year$
EMC	EN50081-1; EN50082-2; IEC61000-4-3
IP Protection Class	IP65; IP67
Explosive-Proof Class	EXIA II CT5

Dimension(mm)

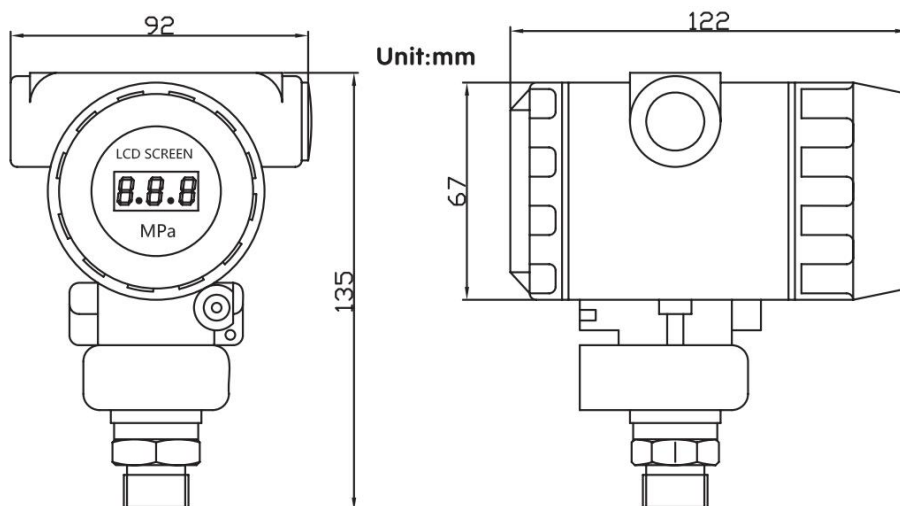

Mechanical Connection(mm)

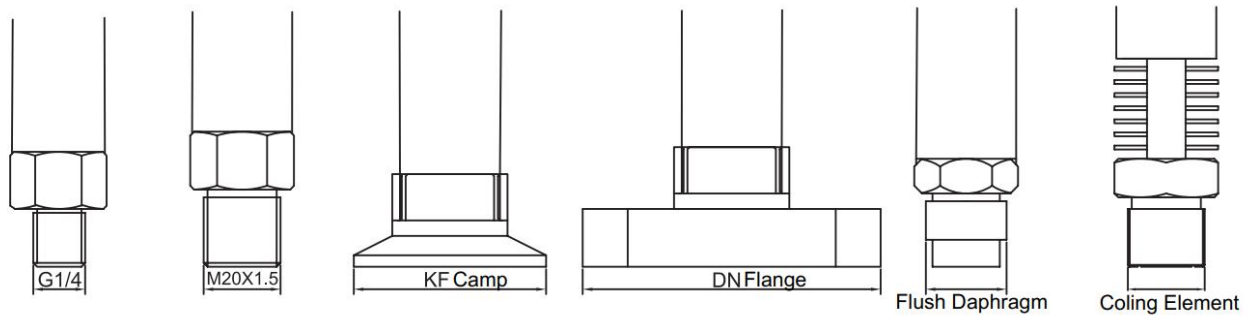

Electronic Connection

4-20mA(2-Wire)	Input +	Red
	Output+	Black
0-10V,0-5V(3-Wire)	Input +	Red
	Input -	Black
	Output+	Green

How To Order

KT-	PC	Z80	E	P	60M	I	P2	J	M3	B1	T1	L		
Category	Type	Setup	Pressure Connection	Pressure Range	Accuracy	Power	Output	Thread	Electrical Connection	Medium Temperature	Additional			
PG	200	High Accuracy	E Lower Mount	None	General Thread	XX (0-30kPa)	1	0.40%	P0 Battery	R RS485	M1 M20*1.5	B Cable Outlet	T1 5~40°C	LC LCD Display
	210	High Accuracy Pressure&Temperature	Z Panel Mount	P	Diaphragm Seals	XB (0-30Bar)	2	0.20%	P2 24V	A 4-20mA	M2 G1/4	C Circular Connector	T2 -20~85°C	LE LED Display
	270	Explosion-Proof	G Wireless	DP	Differential Pressure	XM (0-30MPa)	3	0.10%	P4 220V	J1 Relay	M3 G1/2	CC Customized	T9 Customized	I Explosion-Proof
	280	80mm Dial Size LCD Display	F Peak Record	KF	Clamp	CC Customized	4	0.50%	P5 380V	J2 Dual Relay	M4 1/2NPT			
	260	60mm Dial Size	V Vacuum Switch	DN	Flange		5	0.25%	P6 12V	CC Customized	M5 1/4NPT			
	300	100mm Dial Size	W Water Pump Switch	9999	Customized		9	Customized	P9 Customized		M7 2G1/4			
	380	80mm Dial Size LED Display									M9 Customized			
	560	Digital Remote-transmission												
	625	Contact 60mm Dial Size												
	825	Contact 80mm Dial Size												
925	Contact 90mm Dial Size													
PS	628	60mm Dial Size												
	628	80mm Dial Size												
	928	100mm Dial Size												
	650	Switch Box with Plastic Shell												
	600	Switch Box with Full Metal Shell												
PC	700	Mechanical												
	600	60mm Dial Size												
	800	80mm Dial Size												
	900	100mm Dial Size												

Remark: 1. This form is for whole Pressure Measurement and Pressure Control products, please read Product Date Sheet to get reference informations
2. If you may not find right information in this form, Please contact us to get future details

Shanghai Xuan Precision Technology Co., Ltd.

Address: No. 969, Yunshan Road Pudong District Shanghai City China

Tel: +86 21 59241315

Email: sales@xvyanprecision.com

Website: www.xvyanprecision.com

Product Manager: Tyler Tou

Cell: +86 189 1797 0680

Email: ttao@Xvyanpercision.com