

Pressure Transmitter XY-PTMK11

Typical Feature

- Measurement Range 0~40MPa and optional
- Output 4-20mA, powered by 24VDC
- Stable performance resistance by variable-frequency interference design
- With Reverse Polarity Protection and Current Limiting Protection
- Laser compensation temperature compensation
- Stainless Steel material with fully sealed structure
- Customized structure diversification is available.















Brief Introduction









XY-PTMK11 Pressure Transmitter, is a general type pressure transmitter with cramped construction and micro electronical circuit to keep small size. It' simple installation and good electrical compatibility, diffusion silicon core make it has precision temperature compensation. The temperature ranges from -20oC to 80oC, so the temperature drift is $\pm 0.02\%FS/^{\circ}C$

Stainless steel shell and laser-welded construction, IP65 Ingress protection, insulating strength 500VDC, these electric and mechanical performance allow it to withstand most harsh rugged application environments with high precision, fast response, small size, light-weight, stable and reliable, strong overload capacity characteristics; It is designed for most medium in industry, such as air, steam, oil, water and other fluid; Powered by 24VDC, standard electrical signal output 4-20mA by 2-Wire cable , and 0~5V and 0~10V by 3-Wire cable; Measurement range 0~40MPa, other customized measurement range is available; Thoughtful specialized electric circuit design; high accuracy 0.5% FS; Long-Term Stability $\pm 0.02\%/FS/Year$.

XY-PTMK11 low cost pressure transmitter/transducer can be used in general application like water plant, oil refinery factory, wastewater treatment, construction industry, machinery and other industry and process filed. Machinal joint include thread, flush diaphragm, clamp, flange, radiator and differential two-way fitting.

Suggested Applications

-  Water works
-  Sewage treatment plants
-  Building materials & light industry
-  Mechanical Manufacture
-  Other application that require battery power
-  Machine building and automation
-  Heating, Ventilation and Air Handling
-  Industrial and medical gases
-  Mobile Working Machines
-  Refrigeration
-  Semiconductor Industry
-  Food and Beverage

-  Oil and Gas (Up-, Mid- and Downstream)
-  Petrochemical Industry
-  Chemical Industry
-  Pharmaceuticals and Biotechnology
-  Power Generation
-  Water and Waste Water
-  Basic Materials
-  Fire Protection
-  Agricultural Irrigation

More details for XY-PTMK11, please contact us.

Specification

Model	XY-PTMK11
General Pressure Range	0...1...1.6...10...25...40MPa, Offer customized range
Pressure Type	Gauge Pressure Test
Dimension	Diameter Φ27
Overload Capacity	150%
Insulating Strength	500VDC
Measurement Medium	Gas or Liquid with Compatibility of SS 304
Output Single	4-20mA; Optional 0-5V and 0-10V
Power Supply	24VDC
Accuracy	0.5%FS
Long-Term Stability/Year	Typical: ±0.2% FS/Year
Zero Temperature Drift	Typical: ±0.02%FS/°C; Maximum ±0.05%FS/°C
Sensitivity Temperature Drift	Typical: ±0.02%FS/°C; Maximum ±0.05%FS/°C
Response Time	≤2ms
Operation Temperature	-20 ~ 80°C
Compensation Temperature	-10 ~ 60°C
IP Protection Class	IP65

Dimension(mm)

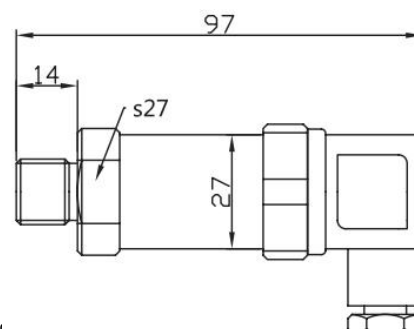
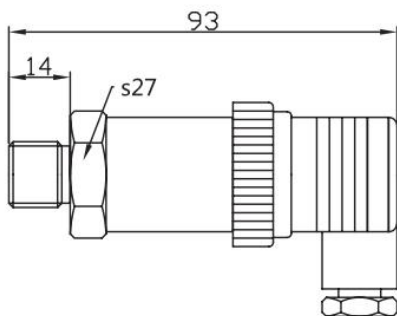

2 / 3

is subject to change with

XVYAN Precision Co., Ltd.
Shanghai 201306

All sales subject to standard terms and conditions

Tel: +86 21 59241315 • Fax: +86 21 59241315
Email: Sales@xvyanprecision.com
Website: www.xvyanprecision.com

Mechanical Connection(mm)

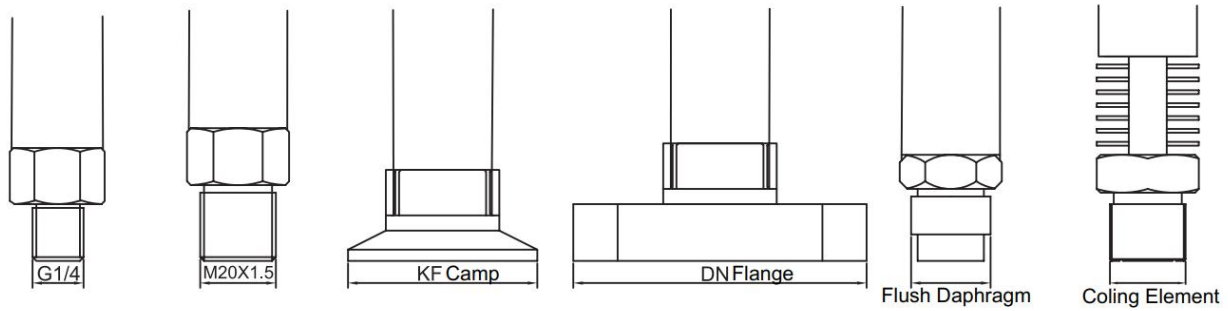

Electronic Connector

4-20mA(2-Wire)	Input +	Red
	Output+	Black
0-10V,0-5V(3-Wire)	Input +	Red
	Input -	Black
	Output+	Green

How To Order

XY-PT	G	KF	4M	1	A	P2	M3	B1	T1	L
Type	Pressure Connection	Pressure Range	Accuracy	Output	Power	Thread	Electrical Connection	dium Temperat	Additional	
G	None	XK (0-XKPa)	1	A	P1	M1	A	T1	L	
GA	P Diaphragm Seals	XB (0-XBar)	2	R RS485	P2	M2	B	T2	I	
DP	DP Differential Pressure	XM (0-XMPa)	3	V1 0-10V	P3	M3	C	T3		
GR	KF Clamp	CC Customized	4	V2 0-5V	P6	M4	CC	T9		
GT	DN Flange		9	V3 0.5-4.5V	P9	M5				
GR	Explosion Proof			CC Customized		M7				
MT	1210 Explosion Proof					M9				
MK	9999 Customized									
HF	High Frequency									
A	Air Conditioning									
B	Ink Corrosion Resistance									
C	Air Compressor									
M	Hydraulic Pressure									
W	Water Pressure									

Shanghai Xuan Precision Technology Co., Ltd.

Address: No. 969, Yunshan Road Pudong District Shanghai City China

Tel: +86 21 59241315

Email: sales@xvyanprecision.com

Website: www.xvyanprecision.com

Product Manager: Tyler Tou

Cell: +86 189 1797 0680

Email: ttao@Xuyanpercision.com