

## Wireless Digital Thermometer XY-TT270

### Typical Feature

- Measure range -50~400 °C
- Accuracy level: 0.2°C
- Operating temperature -20°C ~ 60°C
- LCD display, white backlit
- Wireless transmission GPRS/LORa/NB-iot optional
- Optional Power supply and battery
- With casting aluminum shell and SS304 Joint



### Brief Introduction

XY-TT270 Wireless Digital Thermometer is a low power consumption design powered by batteries. It is a digital thermometer with multiple wireless transmission modes, including GPRS/LORa/ NB-iot, which is redesigned according to wireless digital temperature gauge with static pressure principle.

XY-TT270 is used explosion-proof casting aluminum shell and 304 stainless steel connector joint, built-in high-precision temperature sensors, with LCD display screen, contact plunge-type temperature probe by polyurethane cable, it can be installed easily, good waterproof performance.







It's easy to setup sampling speed, uploading frequency, high-temperature and low-temperature alarm point and Instant temperature alarm, at the same time has many additional functions such as reset, backlit, on/off switch, converting unit, high and low temperature level alarm and so on.

As a wireless digital temperature gauge, it can upload temperature level data on site to cloud server, users can match IP address and other parameters on site or remotely.

The LORa type can work with LORa gateway, have the advantage of low power consumption, long transmission distance, strong signal penetration and AD HOC network.

The NB-iot type is a NB-iot transmission of wireless digital temperature meter, based on NB-iot technology, low power consumption, high transmission efficiency, low cost and other advantages.

### Suggested Applications

-  Heating system,
-  Instruments and apparatus system
-  Laboratory
-  Engineering machine
-  Automatic production line
-  Petrochemical and oil industry
-  Environmental monitoring

**More details for XY-TT270, please contact us.**

Specification

<b>Model</b>	<b>XY-TT270</b>
Temperature Measurement Range	-50~400°C Adjustable by dial switch
Overload Capacity	200%
Accuracy Level	±0.2°C
Output Single	4-20mA
Limiting Current	<25mA
Power Supply	9-30VDC
Temperature Drift Coefficient	Typical 0.005%FS/1°C
Operating Temperature	-40~85°C
Lightning Protection	4000V (≤5 Times)
Anti-Electrical Fast Transient	4000V
Anti-Radio Frequency Interference	>10V/M(80MHz~1000MHz)
Probe Diameter	6mm, other diameters are customized
IP Protection Class	IP65

Dimension(mm)

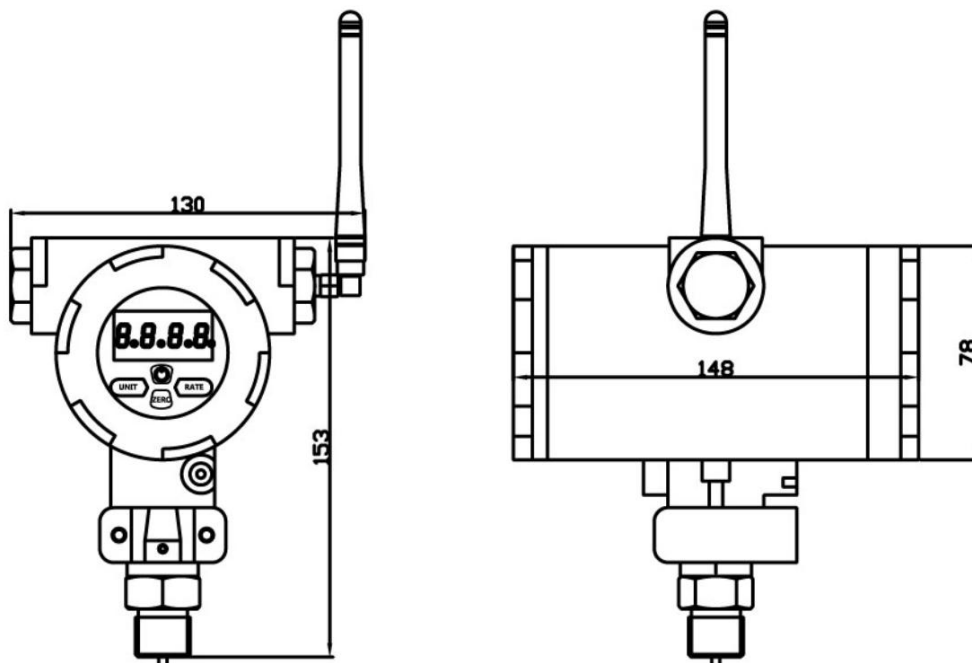

## How To Order

XV-	TT	A	PR	(-50~100°C)	2	P2	A	M1	6	25Meter
	Category	Type	Connection	Range	Accuracy	Power	Output	Thread	Probe Diameter	Probe Length
TG	Temperature Gauge	A Probe B Explosion-Proof 270G Wireless GPRS 270L Wireless LORA 270N Wireless NB-Iot	None PR Probe SA Sanitary KF Clamp TH Thread 9999 Customized	XM (G-X Meter)	2 0.2°C	P0 Battery P2 24V P4 220V P7 9-30V P9 Customized	A 4-20mA	M1 M20*1.5 M2 G1/4 M3 G1/2 M4 1/2NPT M5 1/4NPT M6 Input M7 G3/4 M9 Customized	6 Φ 6mm 8 Φ 8mm 10 Φ 10mm CC Customized	T9 Customized
TT	Temperature Transmitter									

If you may not find right information in this form, Please contact us to get future details

### Shanghai XuYan Precision Technology Co., Ltd.

**Address:** No. 969, YunHan Road Pudong District Shanghai City China

**Tel:** +86 21 59241315

**Email:** sales@xvyanprecision.com

**Website:** [www.xvyanprecision.com](http://www.xvyanprecision.com)

**Product Manager:** Tyler Tou

**Cell:** +86 189 1797 0680

**Email:** ttao@Xuyanpercision.com